

Konica

HEXAR *Silver*



Part Names

■: Reference page ○: OK X: NO

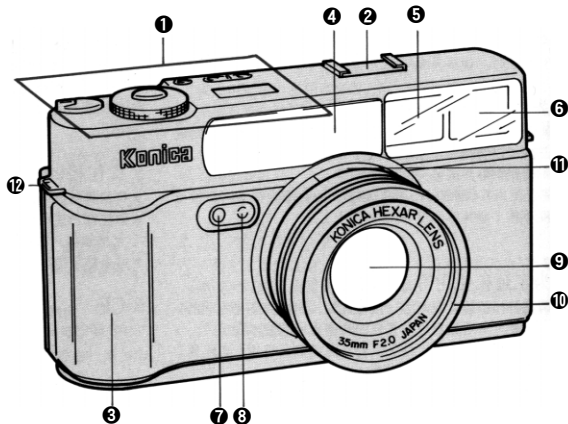

- ① Operation Parts
- ② Accessory Shoe
- ③ Grip
- ④ AF Sensor Window
- ⑤ Finder Brightness Window
- ⑥ View Finder Window
- ⑦ Self-timer Light
- ⑧ AE Sensor Window
- ⑨ Lens
- ⑩ Lens Hood
- ⑪ Focus Indicator
- ⑫ Strap Eyelet

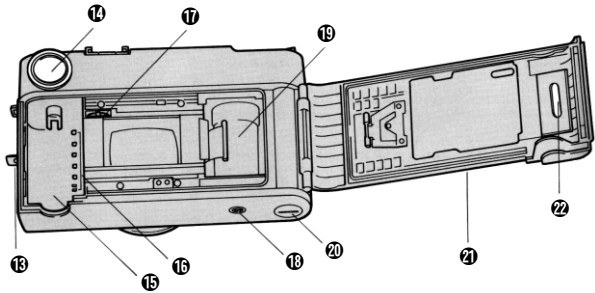

- 13 Back Cover Lock
- 14 Finder Eyepiece
- 15 Film Chamber
- 16 Film Speed Detection Pins
- 17 Film Sprocket
- 18 Tripod Socket
- 19 Film Take-up Spool
- 20 Battery Chamber Cover
- 21 Back Cover
- 22 Film Check Window

1. Operation Parts

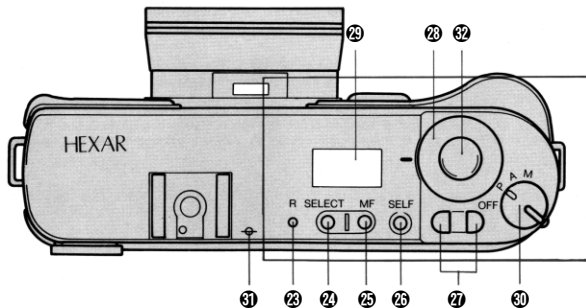

- ②③ Rewind Button
- ②④ SELECT Button
- ②⑤ MF Button
- ②⑥ Self-timer Button
- ②⑦ Up/Down Button
- ②⑧ Aperture Dial
- ②⑨ Display Panel
- ③⑩ Main Switch
OFF: off
P: Program Mode
A: Aperture-priority Mode
M: Manual Mode
- ③① Film Display
- ③② Shutter Release Button

Strap Fitting

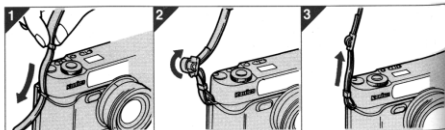

Loading the Battery

When loading the battery, first turn the main switch to M.

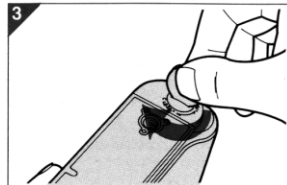
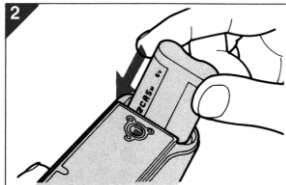
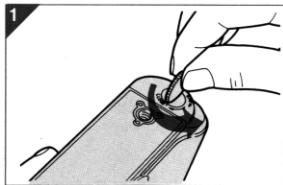

1 When to replace the battery

Turn the Main Switch ON. The following indication will last for about 10 seconds.

Fig. 1

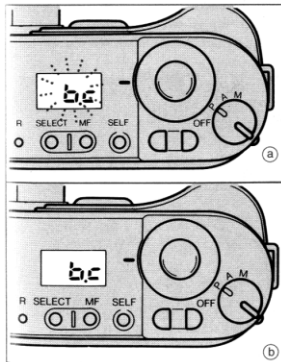

(a) Change battery. (power low)

(b) No power.

* Main switch off before you replace the battery.

* If you replace the battery, set values of camera-shake critical speed, ISO speed, etc. will be canceled.

Basic Functions/Operation

Pressing Shutter Release Button Halfway-down

Fig. 1

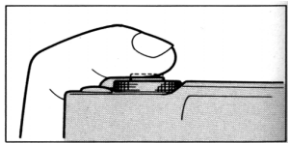

1 Halfway-down Pressing

Press the Shutter Release Button halfway down and hold it with the flat part of your forefinger. Focus, exposure and photo range will be determined.

Fig. 2

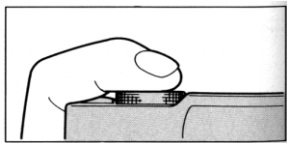

2 Complete Pressing

The shutter will be released.

Fig. 3

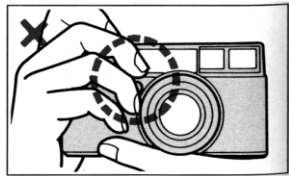

3 Caution: Be careful not to cover the AE sensor and AF sensor parts on the front of the camera with your fingers etc.

Finder Display

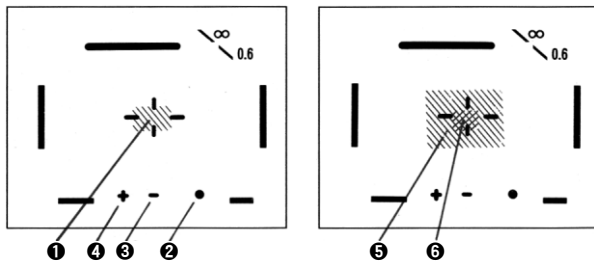

- ❶ AF Frame
- ❷ Focusing Completion Mark
- ❸ Under-exposure Warning Mark
- ❹ Over-exposure Warning Mark
- ❺ AE Frame: A, P Modes
- ❻ AE Frame: M Mode

4 Automatic Compensation of Parallax

Fig. 4

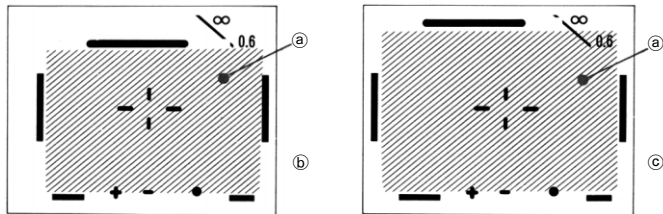

- (a) Photo Range
- (b) In Close Photography
- (c) In Distant Photography

5 Photo Range

Fig. 5

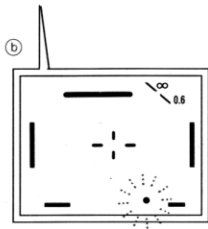

(a) The effective distance range is 0.6 m - infinity.

(b) Too close to the subject.

* Auto Focus does not work with some kinds of dark objects, reflective or light-emitting objects, or very small objects. In such cases, set the Focus Lock by aiming the camera at another object of similar brightness at about the same distance.

Focus Lock Photography



1 Place the AF-Frame on the object.



2 Press the Shutter Release Button halfway down and hold it. Metering range is memorized.



3 Now frame the picture as you wish. Slowly press the Shutter Release Button all the way down.

Film Loading

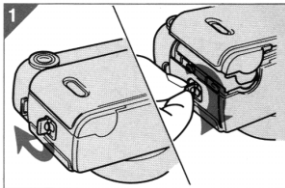

1 Open the Back Cover.

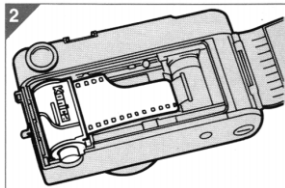

2 Place a film in the Film Chamber.

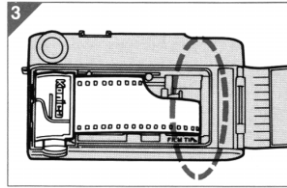

3 Draw out the film tip as far as the FILM TIP mark.

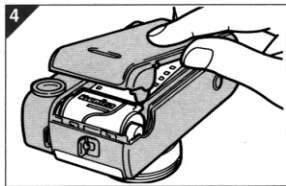

Close the Back Cover.

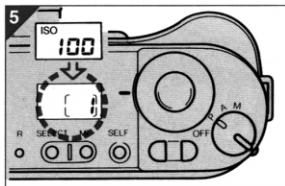

Turn the Main Switch ON. The film will advance to the first frame.

- * When the Main Switch is already set to ON, press the Shutter Release Button.
- * The film speed is displayed and then the frame number is shown.
- * If the frame number isn't displayed, press the SELECT Button.

Fig. 1

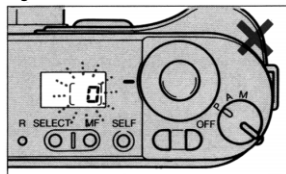

Open the back cover and reload the film.

- * With DX film, film speed (ISO 25-5000) is automatically set. Film Speed Manual setting.

Standard Photography P Mode

This mode prevents failures as much as possible. Based on the specified aperture value, the shutter speed changes according to the brightness. If shutter speed changes are not sufficient for proper exposure, then the aperture is also changed.

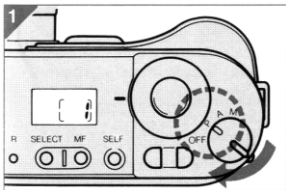

1 Set the Main Switch to P.

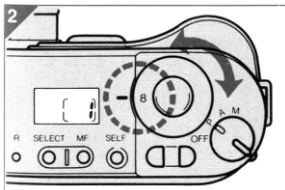

2 Set the Aperture Dial to a standard set value.



3 Frame the subject with the Auto-focus. Frame the subject in the center of the finder. Press Shutter Release Button.

1 Successful Aperture Setting

Fig. 1

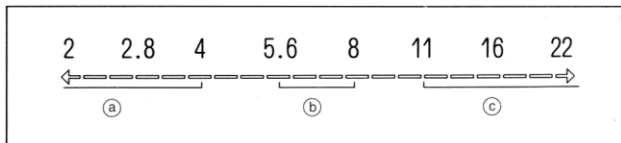

- Ⓐ Increase the shutter speed.
- Ⓑ Standard Set Values
- Ⓒ Enlarge the focus range.

2 Exposure Display (Shutter Release Button halfway down.)

Fig. 2

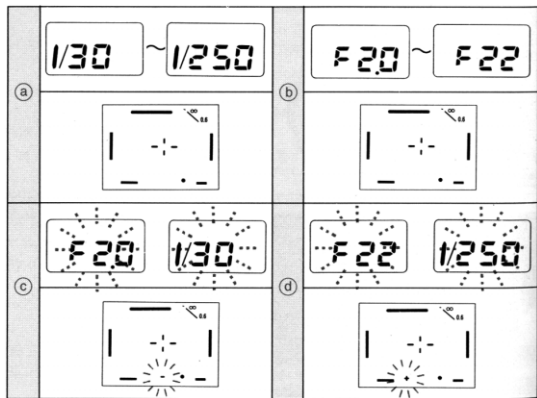

(a) Correct Exposure (Realized with the specified aperture value).

(b) Correct Exposure (Aperture value is changed).

(c) Under Exposure Warning.

(d) Over Exposure Warning.

* When --- is continued to be displayed on display panel, please once set the main switch to M.

3 P Mode Program Chart

Fig. 3

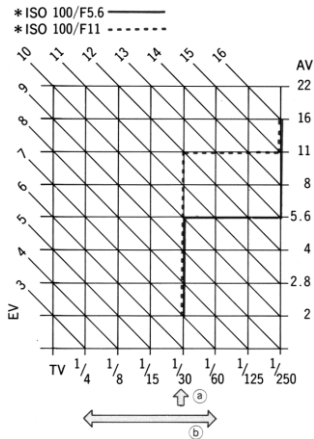

Ⓐ Camera-shake critical speed

Ⓑ Range of choice

Camera-shake Critical Speed

At the time of shipment, the speed is set to 1/30 second.

Range of choice is 1/4 - 1/60 second.

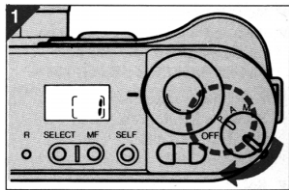

1 Set to P Mode.

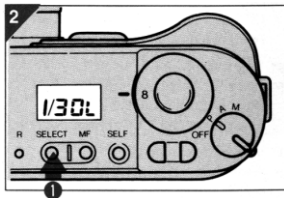

2 Press and hold the SELECT Button for more than a second, and the Camera-shake Critical Speed will be displayed.

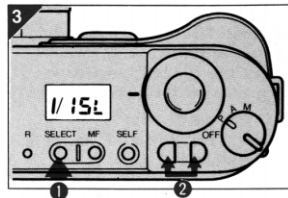

3 Set the value by pressing the Up-Down Button.

Self-timer

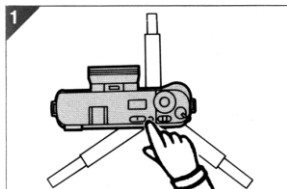

Press the Self-timer Button.

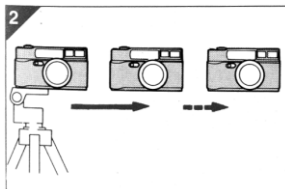

The Self-timer Light will light for 7 seconds and blink for the last 3 seconds before shutter release.

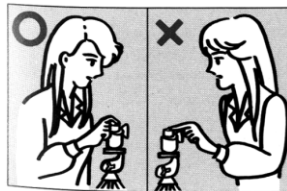

- * To cancel, turn the Main Switch to OFF.
- * Focus and exposure will be set when the Self-timer Button is pressed.

Rewinding

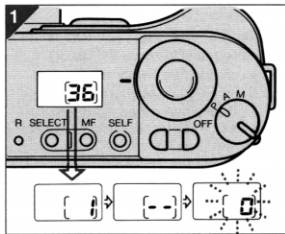

1 When the film is at the end of the roll, the film will automatically rewind.

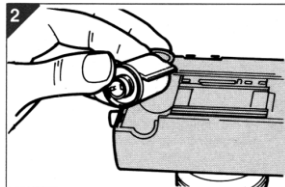

2 Open the Back Cover and take the film out.

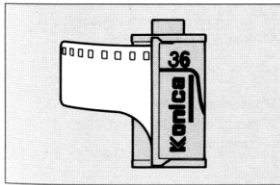
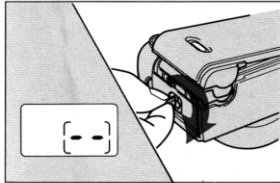

Just before the completion of the rewind, [1] will appear in the Frame Counter Window. The rewind stops with [- -] displayed for about a second.

Now open the back cover.

The film tip will remain outside.

Manual Rewind

(rewinding before the roll is finished)

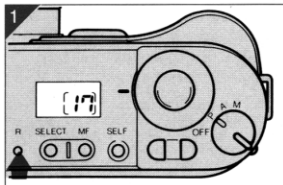

1 Press the Rewind Button.

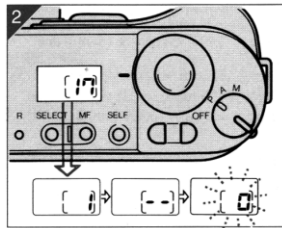

2 The rewinding will start.

Aperture-priority Photography A Mode

In this mode, the shutter speed changes according to the specified aperture value. This mode is convenient in taking the depth of field into consideration, as the aperture values can be fixed.

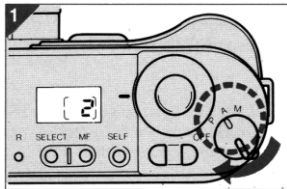

1 Set the Main Switch to A.

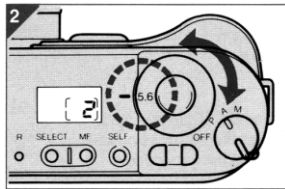

2 Specify the aperture value.

* If the shutter speed exceeds the maximum speed (1/250 sec.) or falls below the lowest speed (30 sec.), the warning symbol will appear in the Finder.

1 Exposure Display (Shutter Release Button halfway down.)

Fig. 1

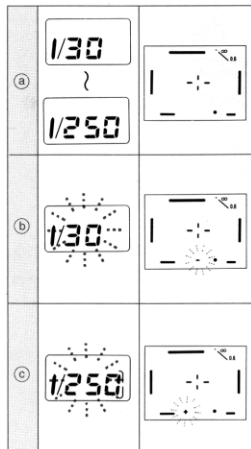

- (a) Correct Exposure
- (b) Under-exposure Warning
- (c) Over-exposure Warning

Depth of Field

Changing the aperture will influence the photo effect.

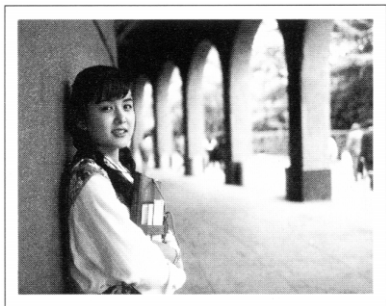

F2 1/250

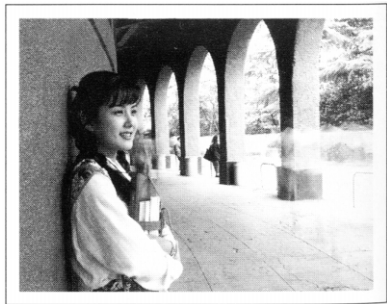

F22 1/2

2 Depth of Field Checking

Fig. 2

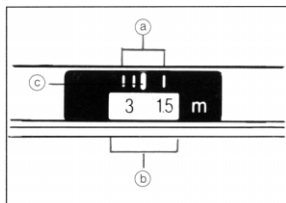

- Ⓐ F8 Depth of Field
- Ⓑ F16 Depth of Field
- Ⓒ Infrared Compensation Index

You can roughly check the depth of field by the Focus Indicator.

3 A Mode Linkage Range

Fig. 3

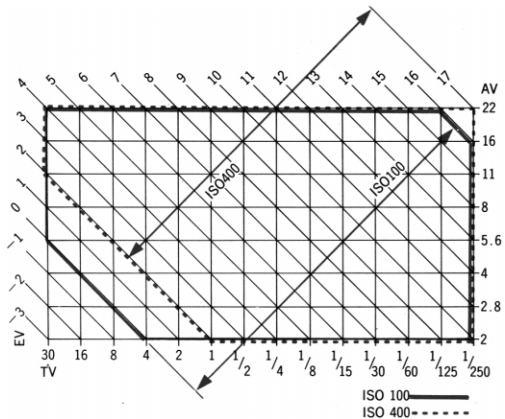

Manual Photography M Mode

In this mode, you manually combine the shutter speed with the aperture at your option.

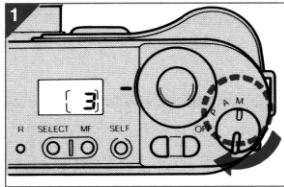

1 Set the Main Switch to M.

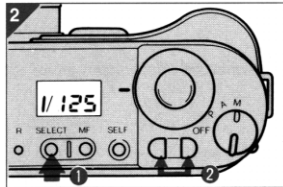

2 Press the SELECT Button. With the shutter speed displayed, press the Up-down Button and specify the shutter speed.

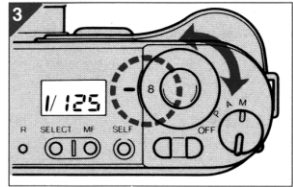

3 Specify the aperture value.

4 Exposure Display (Shutter Release Button halfway down.)

Fig. 4

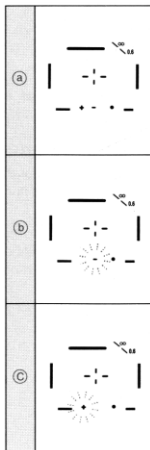

- (a) Correct Exposure
- (b) Under Exposure warning
- (c) Over Exposure Warning

- * If the shutter speed blinks, it means that the exposure exceeds the Exposure Display Range (EV3-18).
- * In this case, correct exposure isn't displayed but the camera is properly controlled at the specified value.

Time Exposure

If you press the Shutter Release Button, the shutter will be left opened.
Press it again, and the shutter will be shut.

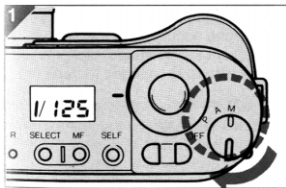

1 Set the Main Switch to M.

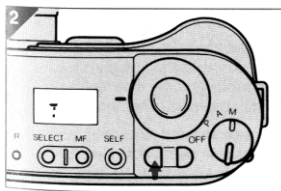

2 Press the Down Button and set the Shutter Speed Display to T.

* During the exposure. "T- -" will be displayed on the Display Panel.

Variable Aperture Synchronization (P Mode)

In this control system, correct exposure is decided according to the outside light to prevent the darkened background. The aperture is changed to meet the correct exposure

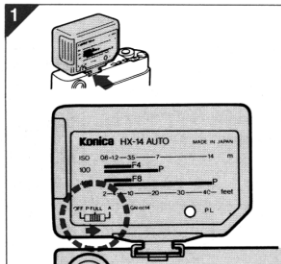

1 Attach the flash to the camera. Set the Flash Switch to P · FULL.

* You can only use the flash specially made for the camera.

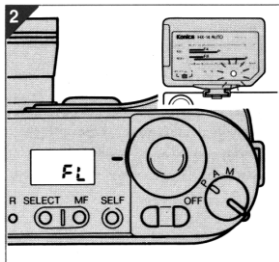

2 When the battery charging is completed, the aperture will be automatically set and [FL] will be displayed on the Display Panel.



1 Aperture Control and Effective Range

Fig. 1

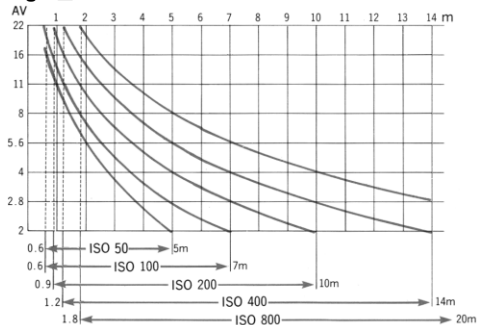

- * If the flash hasn't been charged, the flash will not operate.
- * In this case, ordinary Program AE exposure will be adopted.

INFORMATION

The hot shoe flash can also be used in either A or M modes.

Automatic Flash Photography (A·M Mode)

When the Flash Switch is set to A, it can be used as automatic flash.

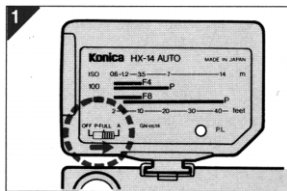

1 Set the Flash switch to A.

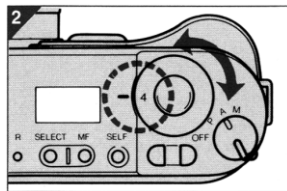

2 Set the aperture value according to the film speed in use.

Fig. 2

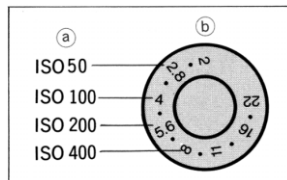

2 Aperture Values at the Automatic Flashing

Ⓐ Film Speed

Ⓑ Specified Aperture Value

Camera movement tends to be a problem during exposure in the A mode in poor light, so for such shots it is advisable to use a tripod.

Manual Flash Photography (A·M Mode)

Set the Flash Switch to P·FULL. You need to adjust the aperture according to the camera-to-subject distance.

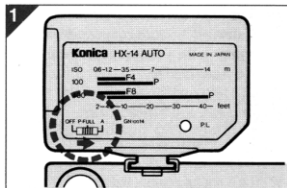

1 The Flash Switch is set to P·FULL.

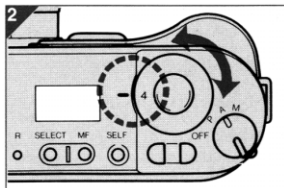

2 Calculate the correct aperture value by using the following format and set the Aperture Dial.

Fig. 3

$$F = \frac{GN^a}{m^b}$$

3 **Format for calculating the correct aperture value**

- a) Correct Aperture Value
- b) Object Distance (m)
- c) 14 (GN/ISO 100)

More Advanced Usage

Exposure Compensation

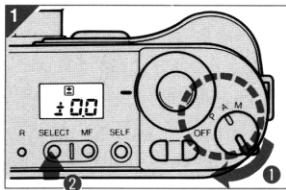

- 1 Set the Main Switch to P or A Mode and press the SELECT Button. Exposure compensation display will appear on the Display Panel.

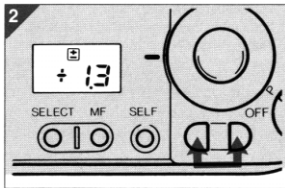

- 2 Specify the compensation value with the Up-down Button.
- * If you press the SELECT Button again, Frame Counter will appear again.



-1.3EV



±0EV



+1.3EV

- * During the exposure compensation, Exposure Compensation Mark is displayed.
- * Main Switch off to cancel.

Film Speed Manual Setting

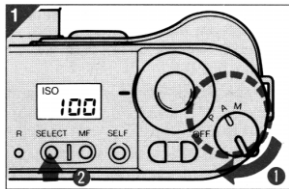

1 Set to A Mode. Press the SELECT Button and hold it for more than a second. ISO speed will be displayed.

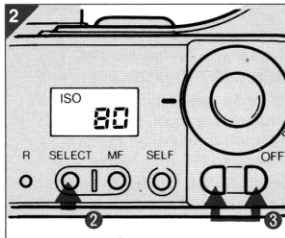

2 Press the Up-down Button and specify the speed.

- * Effective range is ISO 6 ~ 6400.
- * Manual setting should be done after film loading.
- * In displaying the film speeds of more than ISO 1000, the last two digits are abbreviated as H.

Example:

ISO 3200 → ISO 32 H

- * Even if a DX film is used after film speed is specified in non-DX condition, the film speed remains valid when non-DX condition is restored.

Fixed Focus Mode

1 Focus Hold

With this function, focus lock mode is continually maintained.



1 Adjust the AF Frame, then press the Shutter Release Button halfway down.

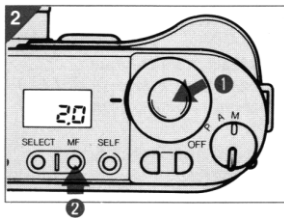

2 Press the MF Button. Focus will be fixed.

2 One Touch Infinity

Press the FM Button, "999" (Infinity) will be fixed.

Fig. 2

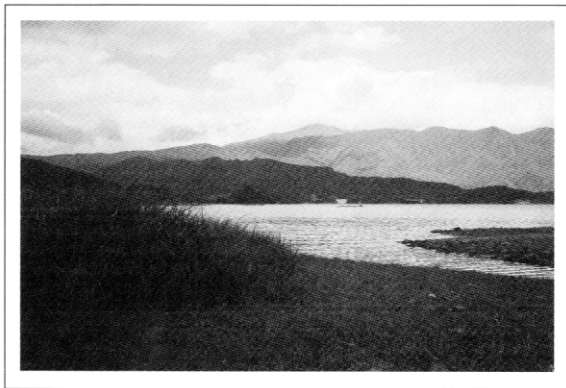
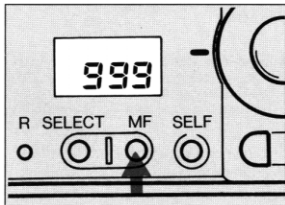

3 Manual Focus

Fig. 3

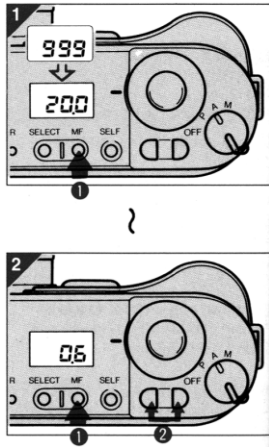

If you press and hold MF Button, “999” will change to the focus display. Press the Up-down Button and specify the focus you want to fix.

* Turning the Main Switch OFF cancels the Mode.

One-touch Exposure Selection Mode

In this mode, the proper shutter speed for the aperture value set in “M” mode is selected automatically.

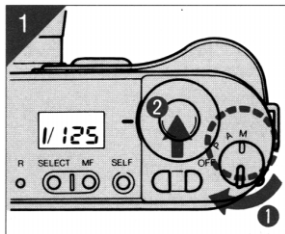

1 Set the Main Switch to “M” and select the desired aperture setting. Press the Shutter release button halfway down and the proper shutter speed will be indicated on the display panel.

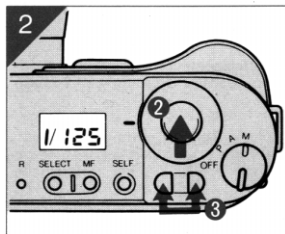

2 Pressing either the UP or DOWN button will then set the shutter to the speed indicated.

Automatic Infrared Focus Correction Mode

This mode allows for one-step compensation of auto-focus focal range when using infrared film.
(Once the focus correction value is set, all exposures on a roll of film are corrected to the same value.)

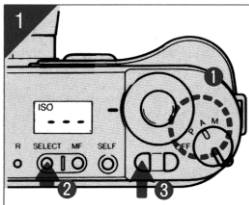

- 1 Load the infrared film in the camera as usual, pressing the shutter release button until “{ ! }” appears in the frame count window. Set the Main Switch to “A” and press the SELECT button hold for while until the ISO speed is shown in the display. Then press the DOWN button until the “ISO···” reading appears.

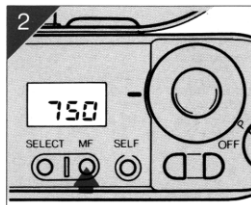

- 2 Then press the MF button once to display “750” or once again to display “850”. These are the wave-length values for infrared films. Choose the correct value for the film in use (refer to table below). After 3 seconds, the display will show “ISO 100” and the selected infrared focus correction value will remain in effect till the end of the roll.

- ★ When using this mode, be sure to use the “M” mode setting to set shutter and aperture values for the film in use following the recommendations of the film manufacturer.
- ★ Once set, Automatic Infrared Focus Correction values remain effective until the roll is finished, even if the Main Switch is turned off.

Note: Use this mode only when using infrared film.

| Wavelength value | Film type |
|------------------|--------------------------------|
| “750” | Konica Infrared 750 film |
| “850” | Kodak High Speed Infrared film |

Multiple Exposure Mode

This mode allows the user to make any number of multiple exposures on a single frame of film.

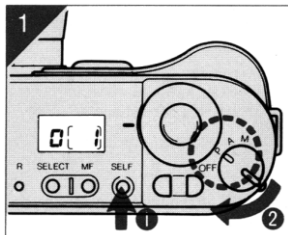

After loading film in the camera, turn the Main Switch from “OFF” to “P” while holding the “SELF” button down. The display panel will read “0 [N]” where “N” is the number of exposures taken. The camera is now in Multiple Exposure mode. Each time the shutter is released the left digit (“N”) will increase by one, but the film is not advanced. (There is no limit on the number of times a single frame can be exposed, but the indicator advances only up to “9”.)

★ When the Main Switch is turned “OFF” the film is advanced to the next frame and Multiple Exposure mode is cancelled.

Manual Guide Number Setting Mode

In this mode, the user can manually set the desired guide number when using a standard flash unit with hot shoe, for fully automatic variable aperture synchronized flash exposures that make use of background lighting as well as flash. (This function is also available in “P” mode with the dedicated flash unit.)

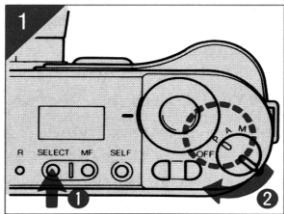

1 Press the SELECT button and turn the Main Switch from “OFF” to “P”.

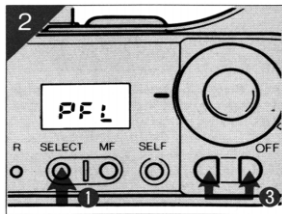

2 While holding the SELECT button down, press the UP or DOWN buttons until the desired flash guide number (“P (1.0 - 64)”) appears in the display panel. When the setting is completed, the display will read “PFL”.

★ Turning the Main Switch back to “OFF” cancels this mode. The same guide number can be reset manually, however, by simply holding down the SELECT button while turning the Main Switch back on.

Note: If the guide number for your flash unit does not match the available settings, choose the next lowest setting. (Example: If desired guide number is 24, select 23.)

Miscellaneous

Auto Date (Auto date only)

This camera has a quartz-controlled auto-date mechanism (clock/calendar) that is programmed through December 31, 2019.

Changing the Display

Press the MODE button and select either date or time.

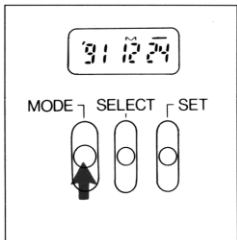

Adjusting Date and Time

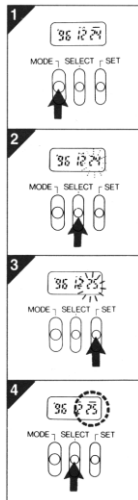

- 1 Press the MODE button and the date or time will be displayed.
- 2 Press the SELECT button so that the date or time blinks.
- 3 Press the SET button to set the date or time.
- 4 Press the SELECT button and the blinking will stop. When the “—” mark appears, setting is finished.

How to replace the back-up battery

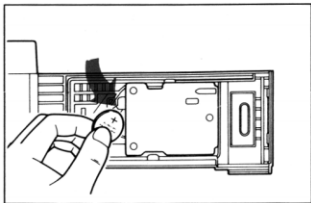
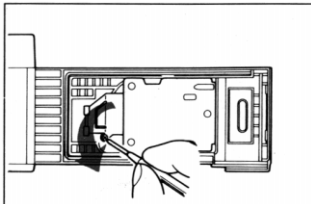

Liquid Crystal Display

The LCD display darkens at high temperatures, and the response is slower at low temperatures. The LCD returns to normal operation at normal temperature.

Specifications

| | |
|--------------------------------------|--|
| Model | 35mm lens shutter type camera with frame format of 24 × 36mm. |
| Lens | Konica Hexar lens of 35mm, F2 (6 groups 7 elements) with minimum aperture F22. |
| Focal Adjustment | Infrared active autofocus system. Manual focus setting available. |
| Shooting Range | 0.6m ~ ∞ (Releasable lock used for out of range) |
| Shutter | Stepper motor driven electromagnetic shutter (T, 30 ~ 1/250 Sec.). |
| Film Sensitivity | Automatic setting for DX coded film (ISO 25 ~ 5000). Manual setting available (ISO 6 ~ 6400). |
| Light Metering Range | SPD photocell used. Center weighted light metering at approx. 15 degrees (EV 0 ~ 16/ISO 100), and spotmetering at approx. 4 degrees (EV 3 ~ 18/ISO 100). |
| Exposure Adjustment (ISO 100) | 3 modes selectable using Main/Shooting Mode switch. P (Programmed AE) Mode for EV 7 ~ 16 (Camera-Shake Critical Speed), A (Aperture Priority AE) Mode for EV 0 ~ 16 and M (Manual) Mode for EV -3 ~ 17 (Except T exposure). |
| Viewfinder | Reverse Galileo type view finder with illuminated bright frame and automatic parallax compensation. Display in viewfinder with focus lock lamp and all data and warnings relevant to exposure and range metering. |
| Film Transport | Electrical wind-up driven by built-in motor and automatic rewinding with function for early rewind. |
| Selftimer | Electronical design with operating time of approx. 10 seconds. Once started, possible to cancel. |
| Display Panel | Number of frame exposed, shutter speed, aperture setting, film sensitivity, exposure compensation, battery check and etc. |
| Other Features | Focus fix function, exposure compensation function (± 2 EV at $1/3$ increment), manual function to set Camera-Shake Critical Speed, automatic power OFF with timer (2 hour) and variable sync shot function when used with dedicated flash. One-touch exposuer selection mode, Automatic infrared focus correction mode, Multiple exposuer mode, Manual guide number setting mode. |
| Autodate | Only available for autodate models. Built-in LCD digital watch able to display year, month and day upto 2019. Possible to record time. |
| Number of rolls photographed | Approx. 200 rolls (24 exposures/roll). |
| Power | Camera: 1 × Lithium battery (2CR5 6V) Auto-date: 1 × Lithium battery (CR2025 3V). |
| Dimensions/Weight | Without Autodate: 137.5 × 76.5 × 64.5mm 490g (Without battery) With Autodate: 137.5 × 76.5 × 67.5mm 490g (Withour battery) |

- * The above performance depends on the company's test conditions.
The specifications and appearance may change without notice.
- * The softcase is available separately. Please consult your dealer.